

Features

- Operates DC - 4 GHz on Single Supply
- ASIC TTL / CMOS Driver
- Low DC Power Consumption
- 50 Ohm Nominal Impedance
- Test Boards are Available
- Tape and Reel are Available
- Lead-Free 4 x 6 mm PQFN Package
- 100% Matte Tin Plating over Copper
- Halogen-Free “Green” Mold Compound
- 260°C Reflow Compatible
- RoHS* Compliant Version of SW90-0002

Description

M/A-COM's MASW-007071-000100 is a SPDT absorptive pHEMT switch with integral TTL driver. This device is in an PQFN plastic surface mount package. This switch offers excellent broadband performance and repeatability from DC to 4 GHz, while maintaining low DC power dissipation. The MASW-007071-000100 is ideally suited for wireless infrastructure applications.

Ordering Information

Part Number	Package
MASW-007071-000100	Bulk Packaging
MASW-007071-0001TR	1000 piece reel
MASW-007071-0001TB	Sample Test Board

Note: Reference Application Note M513 for reel size information.

Pin Configuration^{1,2,3,4}

Pin No.	Function	Pin No.	Function
1	NC	17	NC
2	GND	18	C1
3	RFC	19	NC
4	GND	20	V _{CC}
5	NC	21	NC
6	NC	22	NC
7	GND	23	CP1
8	RF1	24	CP2
9	GND	25	NC
10	NC	26	V _{EE}
11	NC	27	NC
12	V _{EE}	28	NC
13	NC	29	NC
14	V _{CC}	30	GND
15	NC	31	RF2
16	NC	32	GND

1. NC = No Connection
2. VEE is internally generated and must remain isolated from external power supplies. Generated noise is typical of switching DC-DC Converters.
3. Connections and external components shown in functional schematic are required. 0.1 μF Capacitors need to be located near pins 20 & 26.
4. The exposed pad centered on the package bottom must be connected to RF and DC ground. (For PQFN Packages)

Truth Table (Switch)

Control Input	Condition of the Switch	
	RF Common to each RF Port	
C1	RF1	RF2
0	Off	On
1	On	Off

“0” = TTL Low “1” = TTL High

* Restrictions on Hazardous Substances, European Union Directive 2002/95/EC.

ADVANCED: Data Sheets contain information regarding a product M/A-COM is considering for development. Performance is based on target specifications, simulated results, and/or prototype measurements. Commitment to develop is not guaranteed.

PRELIMINARY: Data Sheets contain information regarding a product M/A-COM has under development. Performance is based on engineering tests. Specifications are typical. Mechanical outline has been fixed. Engineering samples and/or test data may be available. Commitment to produce in volume is not guaranteed.

- **North America** Tel: 800.366.2266 / Fax: 978.366.2266
 - **Europe** Tel: 44.1908.574.200 / Fax: 44.1908.574.300
 - **Asia/Pacific** Tel: 81.44.844.8296 / Fax: 81.44.844.8298
- Visit www.macom.com for additional data sheets and product information.

M/A-COM Inc. and its affiliates reserve the right to make changes to the product(s) or information contained herein without notice.

Electrical Specifications: $T_A = 25^\circ\text{C}$, $Z_0 = 50\Omega$

Parameter	Test Conditions	Frequency	Units	Min	Typ	Max
Insertion Loss	RFC—RF1,RF2 (Logic per truth table)	DC - 4.0 GHz	dB	—	—	1.8
Isolation	RF1—RF2 (All Logic "0")	DC - 4.0 GHz	dB	30	—	—
VSWR	On (RFC,RF1, RF2) (Logic per truth table)	DC - 4.0 GHz	Ratio	—	—	2.0:1
VSWR	Off (RF1, RF2) (Logic per truth table)	DC - 4.0 GHz	Ratio	—	—	1.8:1
1 dB Compression	— —	50 MHz 0.5 - 4.0 GHz	dBm dBm	— —	18 29	— —
Input IP ₃	Two-tone inputs up to +5 dBm	50 MHz 0.5 - 4.0 GHz	dBm dBm	— —	36 46	— —
Switching Speed	Ton (50% Control to 10% RF)	—	ns	—	31	—
	Toff (50% Control to 90% RF)	—	ns	—	19	—
	Trise (10% to 90% RF)	—	ns	—	6	—
	Tfall (90% to 10% RF)	—	ns	—	2	—
V _{cc}	—	—	V	4.5	5.0	5.5
V _{IL} V _{IH}	LOW-level input voltage	—	V	0.0	—	0.8
	HIGH-level input voltage	—	V	2.0	—	5.0
I _{in} (Input Leakage Current)	V _{in} = V _{CC} or GND	—	uA	-1.0	—	1.0
I _{cc} ⁵	V _{cc} min to max, Logic "0" or "1"	—	mA	—	5	8
Turn-on Current ⁶	For guaranteed start-up	—	mA	—	—	125
ΔI_{cc} (Additional Supply Current Per TTL Input Pin)	V _{CC} = Max, V _{cntrl} = V _{CC} - 2.1 V	—	mA	—	—	1.0
Switching Noise	Generated from DC-DC Converter with recommended capacitors	3.5 MHz	dBm	—	-93	—
Thermal Resistance θ_{jc}	—	—	°C/W	—	15	—

5. During turn-on, the device requires an initial start up current (I_{cc}) specified as "Turn-on Current". Once operational, I_{cc} will drop to the specified levels.
6. The DC-DC converter is guaranteed to start in 100 μs as long as the power supplies have the maximum turn-on current available for start-up.

Absolute Maximum Ratings^{7,8}

Parameter	Absolute Maximum
Max. Input Power 0.05 GHz 0.5 - 4.0 GHz ⁹	+27 dBm +34 dBm
V _{CC}	-0.5V ≤ V _{CC} ≤ +6.0V
V _{in} ¹⁰	-0.5V ≤ V _{in} ≤ V _{CC} + 0.5V
Operating Temperature	-40°C to +85°C
Storage Temperature	-65°C to +125°C

7. Exceeding any one or combination of these limits may cause permanent damage to this device.
8. M/A-COM does not recommend sustained operation near these survivability limits.
9. When the RF input is applied to the terminated port, the absolute maximum power is +30 dBm.
10. Standard CMOS TTL interface, latch-up will occur if logic signal is applied prior to power supply.

Handling Procedures

Please observe the following precautions to avoid damage:

Static Sensitivity

Gallium Arsenide Integrated Circuits are sensitive to electrostatic discharge (ESD) and can be damaged by static electricity. Proper ESD control techniques should be used when handling these devices.

Recommended PCB Configuration¹¹

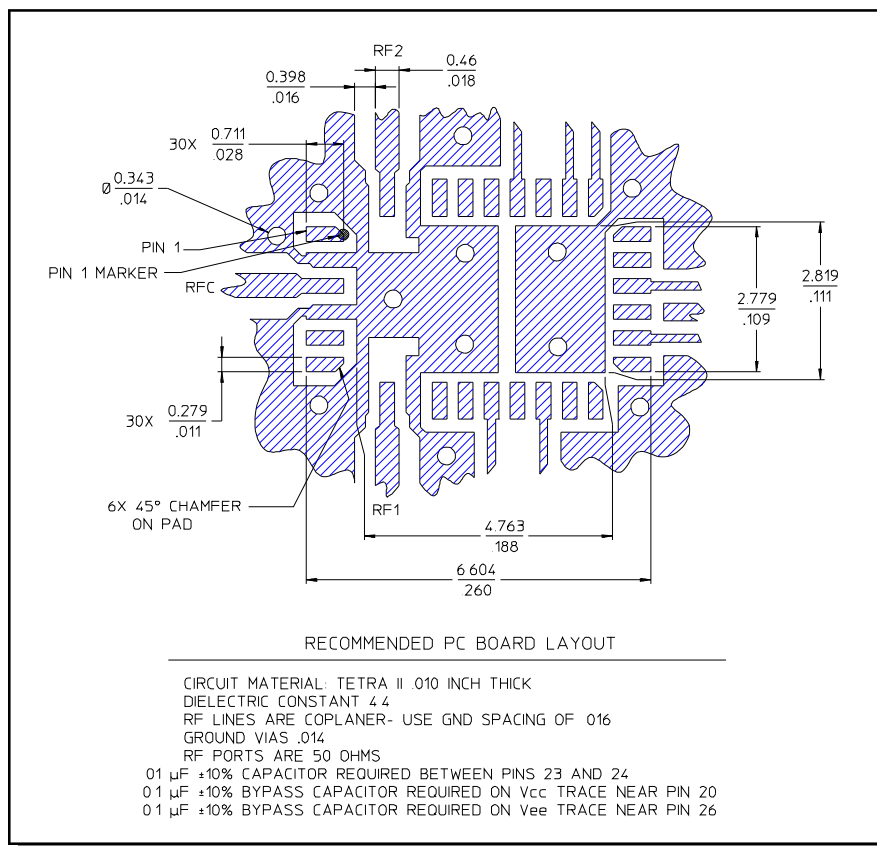

11. Application Note S2083 is available on line at www.macom.com

ADVANCED: Data Sheets contain information regarding a product M/A-COM is considering for development. Performance is based on target specifications, simulated results, and/or prototype measurements. Commitment to develop is not guaranteed.

PRELIMINARY: Data Sheets contain information regarding a product M/A-COM has under development. Performance is based on engineering tests. Specifications are typical. Mechanical outline has been fixed. Engineering samples and/or test data may be available. Commitment to produce in volume is not guaranteed.

- **North America** Tel: 800.366.2266 / Fax: 978.366.2266
 - **Europe** Tel: 44.1908.574.200 / Fax: 44.1908.574.300
 - **Asia/Pacific** Tel: 81.44.844.8296 / Fax: 81.44.844.8298
- Visit www.macom.com for additional data sheets and product information.

M/A-COM Inc. and its affiliates reserve the right to make changes to the product(s) or information contained herein without notice.

Functional Schematic¹²

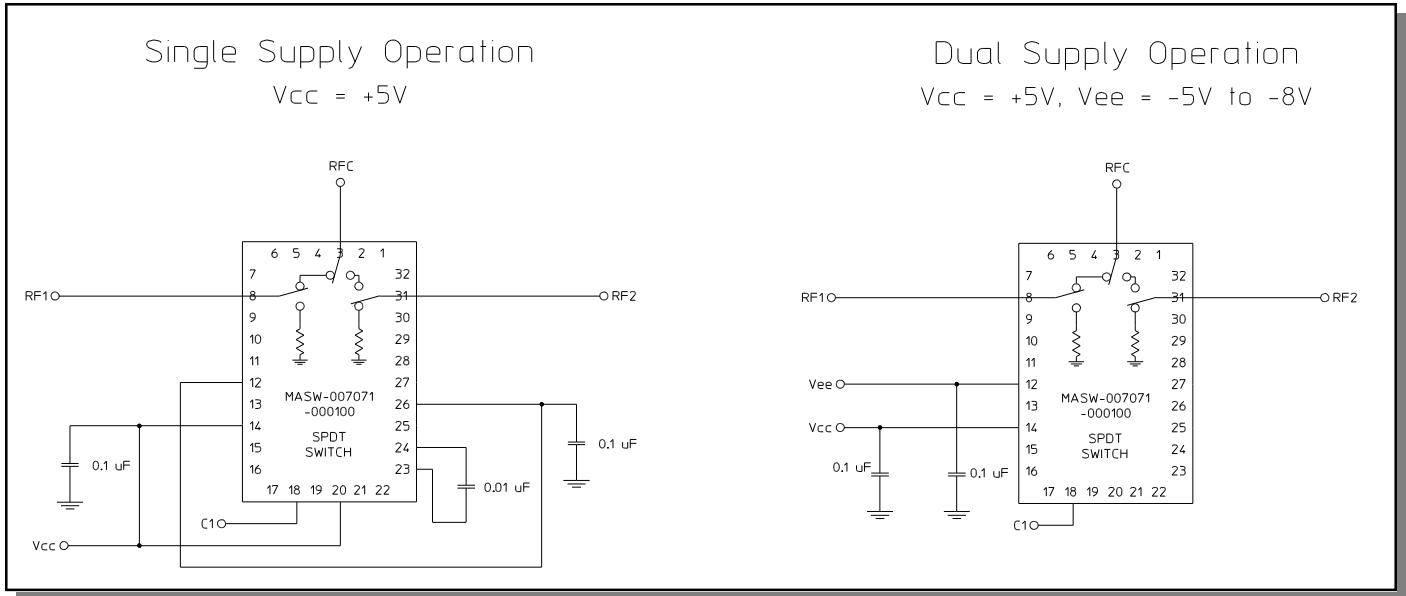

12. Dual Supply Operation will eliminate the start-up current mentioned in Note 5. It will also eliminate spurious signals caused by the DC-DC converter that are present in single supply operation.

Typical Performance Curves

Insertion Loss vs. Frequency

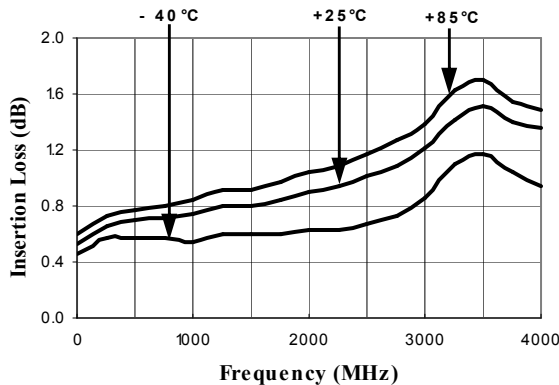

Isolation (dB) vs. Frequency

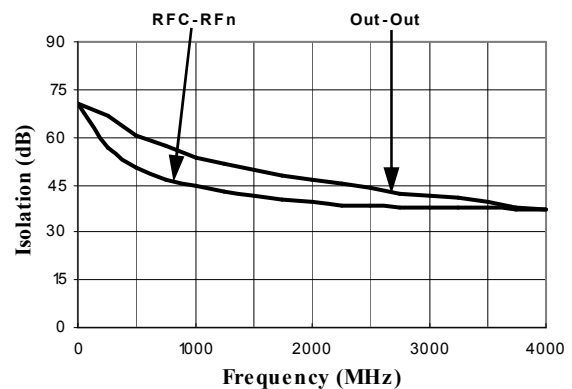

Typical Performance Curves

On VSWR vs. Frequency

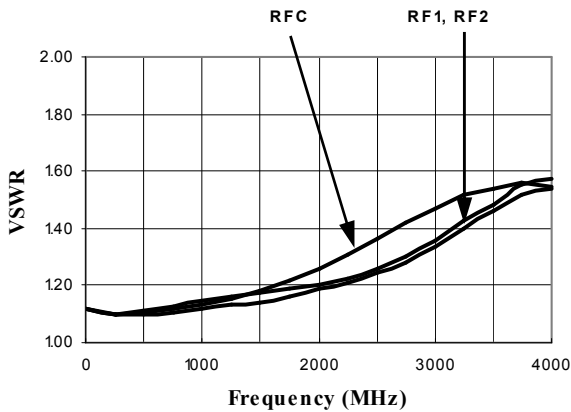

VSWR (Terminations) vs. Frequency

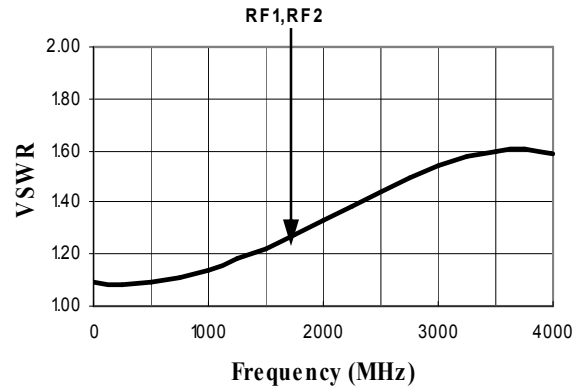

CSP-1, Lead-Free 4 x 6 mm, 32-lead PQFN†

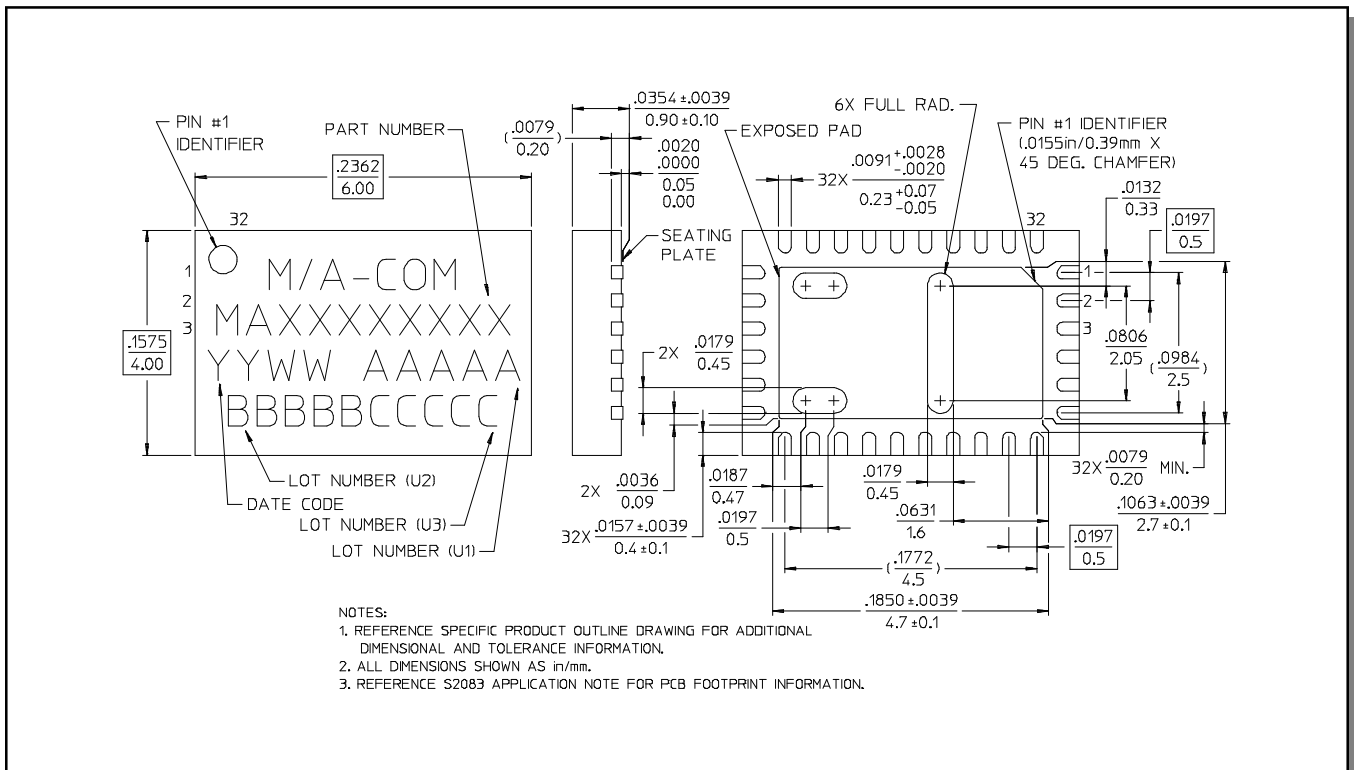

† Reference Application Note M538 for lead-free solder reflow recommendations.

ADVANCED: Data Sheets contain information regarding a product M/A-COM is considering for development. Performance is based on target specifications, simulated results, and/or prototype measurements. Commitment to develop is not guaranteed.

PRELIMINARY: Data Sheets contain information regarding a product M/A-COM has under development. Performance is based on engineering tests. Specifications are typical. Mechanical outline has been fixed. Engineering samples and/or test data may be available. Commitment to produce in volume is not guaranteed.

- **North America** Tel: 800.366.2266 / Fax: 978.366.2266
- **Europe** Tel: 44.1908.574.200 / Fax: 44.1908.574.300
- **Asia/Pacific** Tel: 81.44.844.8296 / Fax: 81.44.844.8298

Visit www.macom.com for additional data sheets and product information.

M/A-COM Inc. and its affiliates reserve the right to make changes to the product(s) or information contained herein without notice.